





### ADDITIONAL OPTIONS

OPTION	OPTION DESIGNATOR	DESCRIPTION																												
Nylon jacketed wire rope (Ranges to 80" only)	<b>NJC</b>	Replaces standard stainless steel wire rope with Ø.018 nylon jacketed wire rope. This option increases wire rope life dramatically but may increase non-linearity by as much as ±.05% of full scale.																												
Nylon jacketed wire rope (Ranges 100" to 500" only)	<b>NJC037</b>	Replaces standard stainless steel wire rope with Ø.037 nylon jacketed wire rope.																												
Reversed output	<b>R</b>	Output is at a maximum when wire rope is fully retracted. Output decreases as wire rope is extended. Does not apply to velocity signal.																												
NEMA 6, IP-68 capability	<b>N6</b>	 <p>Connector is replaced with a bulkhead fitting and a designated length of urethane jacketed, shielded, twisted pair cable. Retraction mechanism and electrical components are sealed to NEMA 6, IP-68 capability. No connector.</p>																												
Corrosion Resistant Construction	<b>SS</b>	<p>All external anodized aluminum parts of transducer are replaced with stainless steel and corrosion resistant plastic. Transducer is sealed to NEMA 6, IP-68 capability. Urethane jacketed, shielded, twisted pair cable exits unit. No connector.</p> 																												
Non-standard potentiometer (Applies to HX-PA only)	<b>PXK</b>	<p>Replace "X" in option designator with required potentiometer value in K ohms. Non-standard potentiometer linearity is as follows:</p> <p>Ranges 0 to 2" to 0 to 5" ..... ±1.00% of full scale            Ranges 0 to 10" to 0 to 25" ..... ±0.50% of full scale            Ranges 30" and above ..... ±0.25% of full scale            Note: This option is subject to potentiometer availability.</p>																												
Alternate wire rope exit Measurement ranges to 80" (2.0 m)	<b>E1, E2, E3</b>	 <table border="1"> <thead> <tr> <th>RANGE</th> <th>"A"</th> <th>"B"</th> <th>"C"</th> </tr> </thead> <tbody> <tr> <td>2", 10"</td> <td>1.12 (28.4)</td> <td>1.79 (45.5)</td> <td>1.21 (30.7)</td> </tr> <tr> <td>3", 15", 30"</td> <td>.96(24.4)</td> <td>1.95 (49.5)</td> <td>1.37 (34.8)</td> </tr> <tr> <td>4", 20", 40"</td> <td>.80 (20.3)</td> <td>2.11 (53.6)</td> <td>1.53 (38.9)</td> </tr> <tr> <td>5", 25", 50"</td> <td>.64 (16.3)</td> <td>2.27 (57.7)</td> <td>1.69 (42.9)</td> </tr> <tr> <td>6", 60"</td> <td>.49 (12.4)</td> <td>2.42 (61.5)</td> <td>1.84 (46.7)</td> </tr> <tr> <td>80"</td> <td>.25 (6.4)</td> <td>2.66 (67.6)</td> <td>2.08 (52.8)</td> </tr> </tbody> </table> <p>Dimensions in brackets are millimeters.</p>	RANGE	"A"	"B"	"C"	2", 10"	1.12 (28.4)	1.79 (45.5)	1.21 (30.7)	3", 15", 30"	.96(24.4)	1.95 (49.5)	1.37 (34.8)	4", 20", 40"	.80 (20.3)	2.11 (53.6)	1.53 (38.9)	5", 25", 50"	.64 (16.3)	2.27 (57.7)	1.69 (42.9)	6", 60"	.49 (12.4)	2.42 (61.5)	1.84 (46.7)	80"	.25 (6.4)	2.66 (67.6)	2.08 (52.8)
RANGE	"A"	"B"	"C"																											
2", 10"	1.12 (28.4)	1.79 (45.5)	1.21 (30.7)																											
3", 15", 30"	.96(24.4)	1.95 (49.5)	1.37 (34.8)																											
4", 20", 40"	.80 (20.3)	2.11 (53.6)	1.53 (38.9)																											
5", 25", 50"	.64 (16.3)	2.27 (57.7)	1.69 (42.9)																											
6", 60"	.49 (12.4)	2.42 (61.5)	1.84 (46.7)																											
80"	.25 (6.4)	2.66 (67.6)	2.08 (52.8)																											
Alternate wire rope exit Measurement ranges 100" (2.5 m) and greater.	<b>E1, E2, E3</b>	 <p>Dimensions in brackets are millimeters.</p>																												

Specifications subject to change without notice.

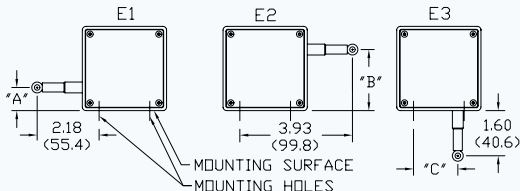
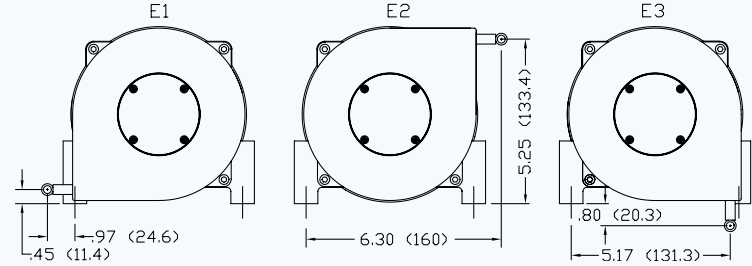
# HX SERIES

## SUPPLEMENTAL DATA

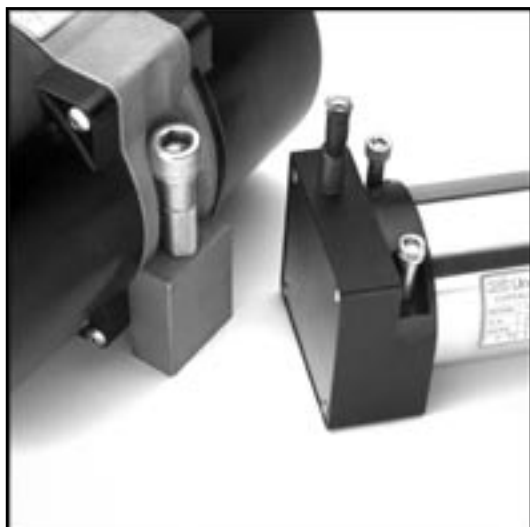

Typical HX mounting bolts.

### MECHANICAL SPECIFICATIONS

#### Mechanical Specifications

Available Measurement Ranges.....	See Table 12
Construction	
Ranges 80" (2 m) and under.....	Anodized Aluminum Mounting Base, Stainless Steel & Anodized Aluminum Housing
Ranges 100" (2.5 m) and greater .....	Stainless Steel Mounting Base High Impact, Corrosion Resistant Thermoplastic Housings
Wire Rope Tension .....	See Table 12
Wire Rope Diameter.....	See Table 12
Weight .....	See Table 12
Connector.....	MS3102A-14S-6P
Mating Connector (included) .....	MS3106E-14S-6S
Optional NEMA 6 Capability.....	Bulkhead fitting with shielded, twisted pair cable
Life*	
Ranges 2" to 6" .....	5,000,000 full stroke cycles
Ranges 10" to 25" .....	500,000 full stroke cycles
Ranges 30" to 400" .....	250,000 full stroke cycles
Ranges 500" to 2000" .....	200x10 <sup>6</sup> lineal inches

\* with 1K ohm potentiometer, wire rope misalignment 2° maximum at full stroke, relatively dust free environment, nylon jacketed wire rope on units with ranges 80" and less.

Use value from this column to indicate overall measurement range

Check mark indicates available measurement range

# TABLE 12

MEASUREMENT RANGE DESIGNATOR	STANDARD MEASUREMENT RANGES		APPLICABLE SERIES			WIRE ROPE TENSION (NOMINAL)		WIRE ROPE DIAMETER		TRANSDUCER WEIGHT		Product Photo	
	(in)	(mm)	HX-PA HX-PB HX-P420 HX-P510 HX-P1010	HX-EP	HX-V HX-VP	(oz)	(N)	(in)	(mm)	(lb)	(Kg)		
2	2	50	✓	-	✓	34	9.4	.016	0.4	2	0.9		
3	3	75	✓	-	✓	24	6.7	.016	0.4	2	0.9		
4	4	100	✓	-	✓	24	6.7	.016	0.4	2	0.9		
5	5	125	✓	-	✓	19	5.3	.016	0.4	2	0.9		
6	6	150	✓	-	✓	24	6.7	.016	0.4	2	0.9		
10	10	250	✓	✓	✓	34	9.4	.016	0.4	2	0.9		
15	15	390	✓	-	✓	24	6.7	.016	0.4	2	0.9		
20	20	500	✓	-	✓	24	6.7	.016	0.4	2	0.9		
25	25	640	✓	✓	✓	19	5.3	.016	0.4	2	0.9		
30	30	750	✓	-	✓	24	6.7	.016	0.4	2	0.9		
40	40	1000	✓	-	✓	24	6.7	.016	0.4	2	0.9		
50	50	1250	✓	✓	✓	19	5.3	.016	0.4	2	0.9		
60	60	1500	✓	✓	✓	24	6.7	.016	0.4	2	0.9		
80	80	2.0m	✓	✓	✓	21	5.8	.016	0.4	2	0.9		
100	100	2.5m	✓	✓	✓	36	10.0	.024	0.6	6.8	3.1		
120	120	3.0m	✓	✓	✓	36	10.0	.024	0.6	6.8	3.1		
150	150	3.8m	✓	✓	✓	36	10.0	.024	0.6	6.8	3.1		
200	200	5.0m	✓	✓	✓	36	10.0	.024	0.6	6.8	3.1		
250	250	6.3m	✓	✓	✓	36	10.0	.024	0.6	6.8	3.1		
300	300	7.5m	✓	✓	✓	36	10.0	.024	0.6	6.8	3.1		
350	350	8.8m	✓	✓	✓	36	10.0	.024	0.6	6.8	3.1		
400	400	10.0m	✓	✓	✓	36	10.0	.024	0.6	6.8	3.1		
500	500	12.5m	✓	✓	✓	36	10.0	.024	0.6	8.6	3.9		
600	600	15.2m	✓	✓	✓	36	10.0	.024	0.6	8.6	3.9		
800	800	20.3m	✓	✓	✓	36	10.0	.024	0.6	8.6	3.9		
1000	1000	25.4m	✓	✓	-	36	10.0	.024	0.6	12.0	5.4		
1200	1200	30.4m	✓	✓	-	36	10.0	.024	0.6	12.3	5.6		
1600	1600	40.6m	✓	✓	-	36	10.0	.024	0.6	14.1	6.4		
1800	1800	45.7m	✓	✓	-	36	10.0	.021	0.6	15.9	7.2		
2000	2000	50.8m	✓	✓	-	36	10.0	.021	0.5	16.3	7.4		

Specifications subject to change without notice.

### DIMENSIONAL INFORMATION

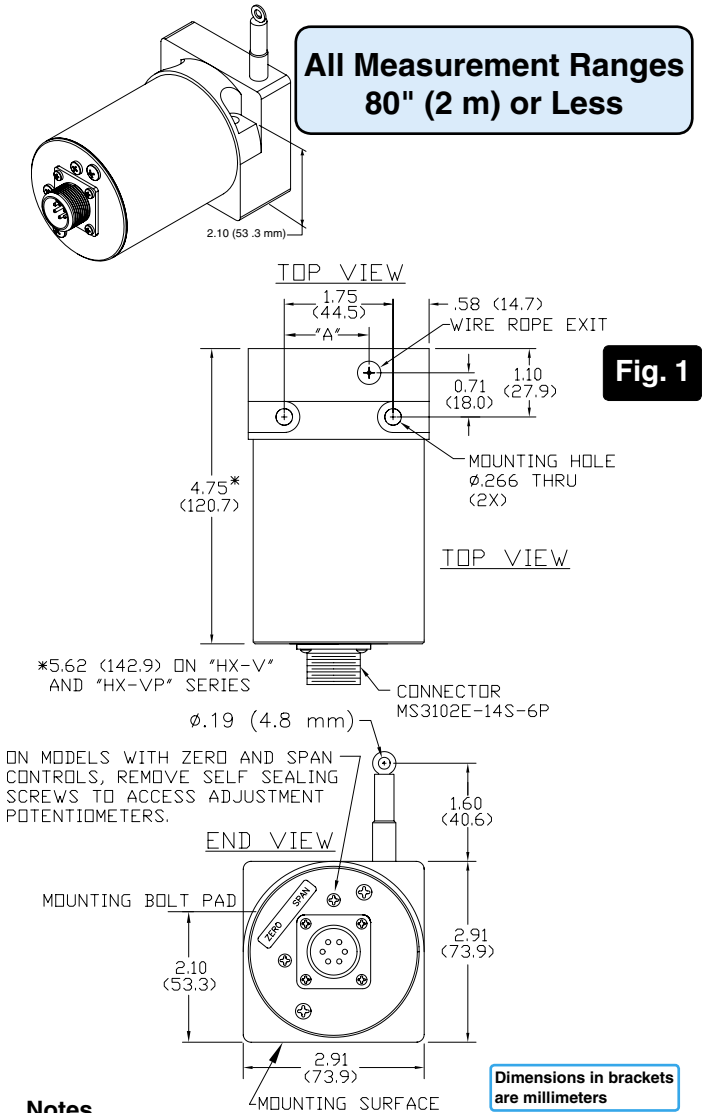

#### Notes

1. Transducer mounts with  $\phi$ .25 or M6 socket head cap bolts.

**Table 13**

RANGE	"A"
2", 10"	1.21 (30.7)
3", 15", 30"	1.37 (34.8)
4", 20", 40"	1.53 (38.9)
5", 25", 50"	1.69 (42.9)
60"	1.84 (46.7)
80"	2.08 (52.8)

**Table 14**

RANGE	DIM "A"	DIM "B"
Ranges to 800"	7.70 (196)	3.80 (97)
1000" to 2000"	11.0 (280)	5.60 (142)

#### Notes

1. Transducer mounts with  $\phi$ .50 or M12 socket head cap bolts.  
 2. Dimension "C" is the cable offset that occurs as the cable is extended from the transducer.

For "C" in inches,  $C = .0016 \times E$  where E = extension in inches.

For "C" in millimeters,  $C = .0016 \times E$  where E = extension in mm.

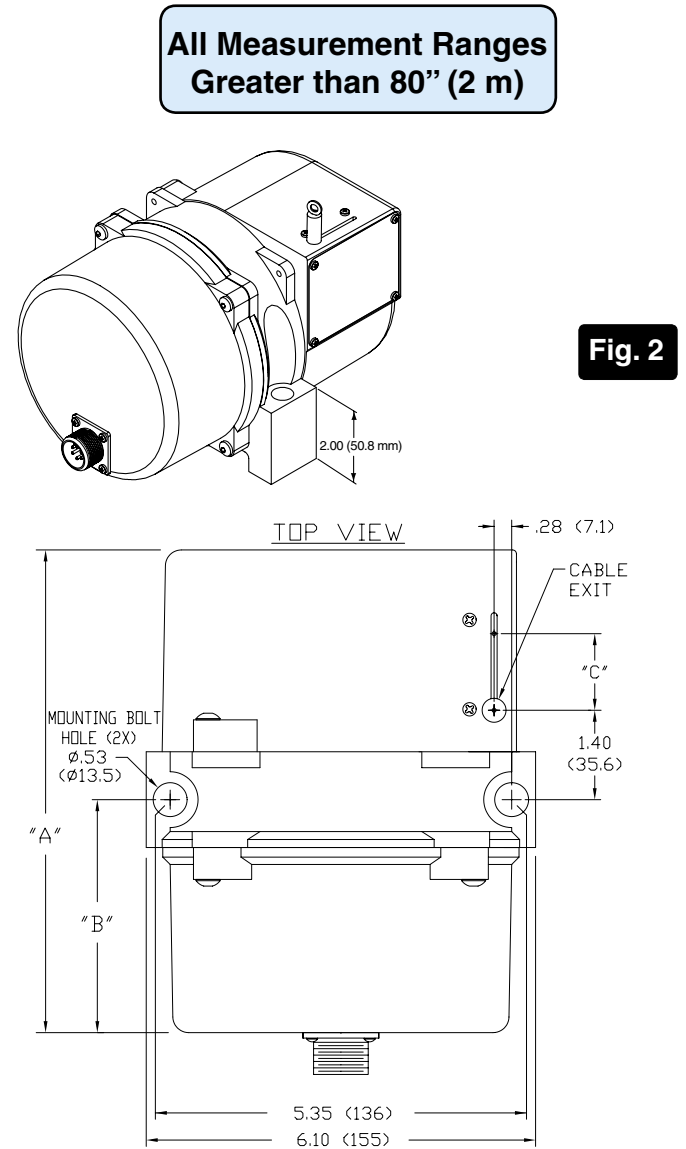

ON MODELS WITH ZERO AND SPAN CONTROLS, REMOVE SELF SEALING SCREWS TO ACCESS ADJUSTMENT POTENTIOMETERS.

Specifications subject to change without notice.